

Powerdrive PL-HT
ECdrive H
DCU1-NT-OP

Original operating instructions
EN User manual

168222-03



Contents

1	General safety notices	3
2	Description	4
2.1	Intended use.....	4
2.2	General information about safety and danger zones.....	4
2.3	Information about safety and danger zones for Powerdrive PL-HT and ECdrive H.....	5
2.4	Information about safety and danger zones for Powerdrive PL-HT	6
2.5	Set-up.....	7
3	Operation	8
3.1	Normal operation	8
3.2	Selecting the mode of operation.....	10
3.3	Blocking and releasing the operating mode	12
4	No mains voltage.....	13
5	Fault messages	14
5.1	TPS/DPS.....	14
5.2	MPS/MPS-ST.....	14
6	What to do if...?	14
7	Cleaning and maintenance.....	16
7.1	Cleaning	16
7.2	Maintenance.....	16
7.3	Rechargeable battery.....	16
8	Safety-related inspection by trained professionals.....	17
9	Technical data	17
9.1	General data	17
9.2	Dimensions	17

About these instructions

Symbols and explanations

Important information and technical notes are highlighted to explain correct operation.

Symbol	Meaning
	means "important note"
	means "additional Information"

Product liability

In accordance with the liability of the manufacturer for its products as defined in the German "Product Liability Act", compliance with the information contained in this brochure (product information and proper use, misuse, product performance, product maintenance, obligations to provide information and instructions) must be ensured. Failure to comply releases the manufacturer from their statutory liability.

1 General safety notices

Carefully read and abide by this user manual before commissioning the door. In addition, always observe the following safety notices:

- Any relevant additional country-specific and European directives must also be observed.
- Operating, maintenance and repair conditions specified by GEZE must be observed.
- Maintenance and repair work may only be performed by properly trained personnel authorised by GEZE.
- GEZE shall assume no liability for damage caused by unauthorised changes to the system.
- Use in dry rooms only.
- The owner is responsible for safe operation of the system. Should safety devices be misaligned, thus preventing them from fulfilling their intended purpose, further operation is not permissible. Inform the service technician immediately in this case.
- In compliance with Machine Directive 2006/42/EC, a safety analysis (risk analysis) must be performed and the door system identified in compliance with CE Identification Directive 93/68/EEC before commissioning the door system. Use the "GEZE safety analysis for automatic sliding doors" here.
- The intervals for safety-related testing are to be complied with based on the country-specific regulations.

2 Description

2.1 Intended use

- The automatic door systems Powerdrive PL-HT and ECdrive H are not intended for the following uses.
 - for use in escape and rescue routes
 - for use at fire barriers
- The automatic door systems Powerdrive PL-HT and ECdrive H are intended for use in medical areas.
- The automatic door system Powerdrive PL-HT is only intended for use by persons who have been instructed in the function of lowering door leaves and in operating the door handle.

The sliding door systems differ in respect of the following functions and features:

	Powerdrive PL-HT	ECdrive H
Linear door leaf movement	✓	✓
Sealed closing leaf in closed position	✓	-
Hermetic closing movement:	✓	-
Lowering and pressing of the door leaf against the wall		
1-leaf design	✓	✓
2-leaf design	-	✓
Sound proofing	-	-

2.2 General information about safety and danger zones



Danger zones are caused at automatic doors due to the movement of the door leaves.

These danger zones can be secured through appropriate safety measures such as observing safety distances and mechanical or electrical protection.

A safety analysis has to be drawn up by the by the installer of the system for each door before commissioning. Use the "GEZE safety analysis for automatic sliding doors" document for this.

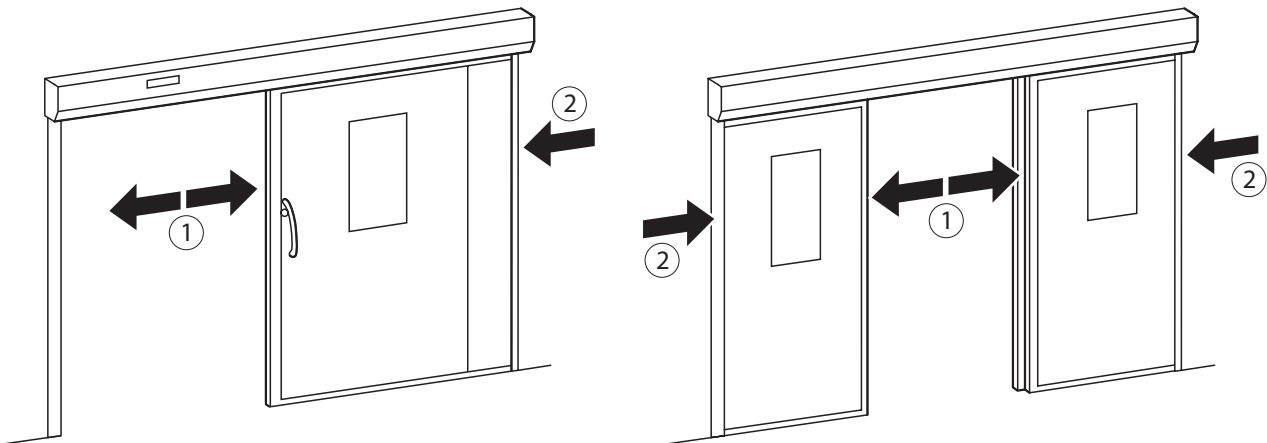

- 1 Danger zone between the main closing edge and opposite closing edge (danger of collision and crushing)
- 2 Danger zone between the secondary closing edge and opposite closing edge / wall (danger of collision and crushing)

2.3 Information about safety and danger zones for Powerdrive PL-HT and ECdrive H

For door leaves, which are fitted with a handle for opening the doors using the Push & Go function, there are the following additional dangers and restrictions:

- Risk of collision and/or crushing between handle and wall.
- Danger of catching clothing on the handle.

Danger zones on the handle

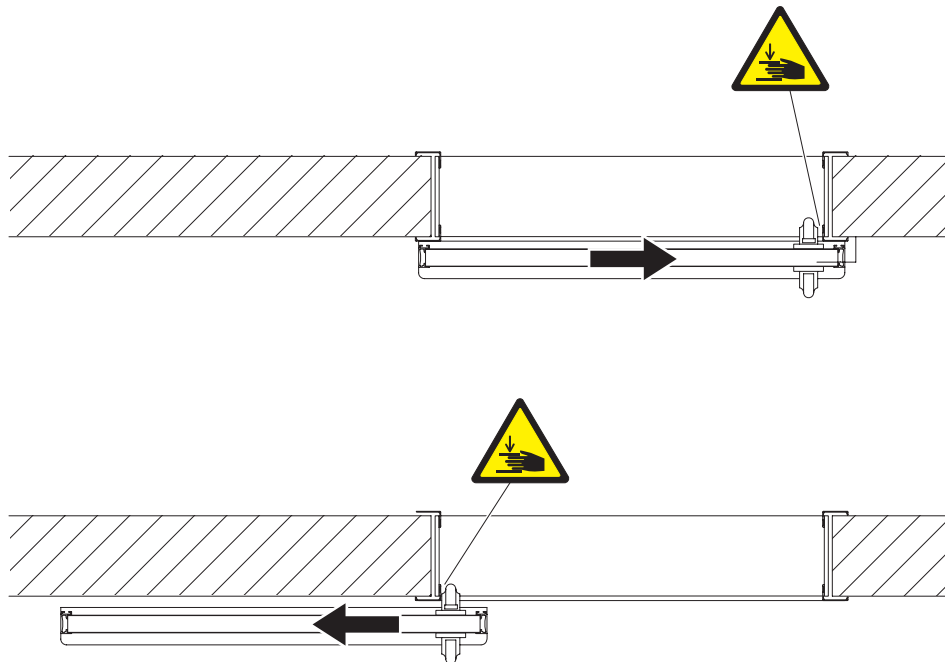

2.4 Information about safety and danger zones for Powerdrive PL-HT

For door leaves, which are fitted with a handle for lifting the doors using when opening and using the Push & Go function, there are the following additional dangers and restrictions:

- Risk of collision and/or crushing between handle and wall or handle and door.
- Risk of collision and/or crushing from a person on the opposite handle.
- Danger of catching clothing on the handle.

When closing the door leaf, the leaf lowers towards the floor in order to create a seal.

This results in an additional risk of crushing / residual risk between the door leaf and floor.

Danger zone between door leaf and floor when the door leaf lowers

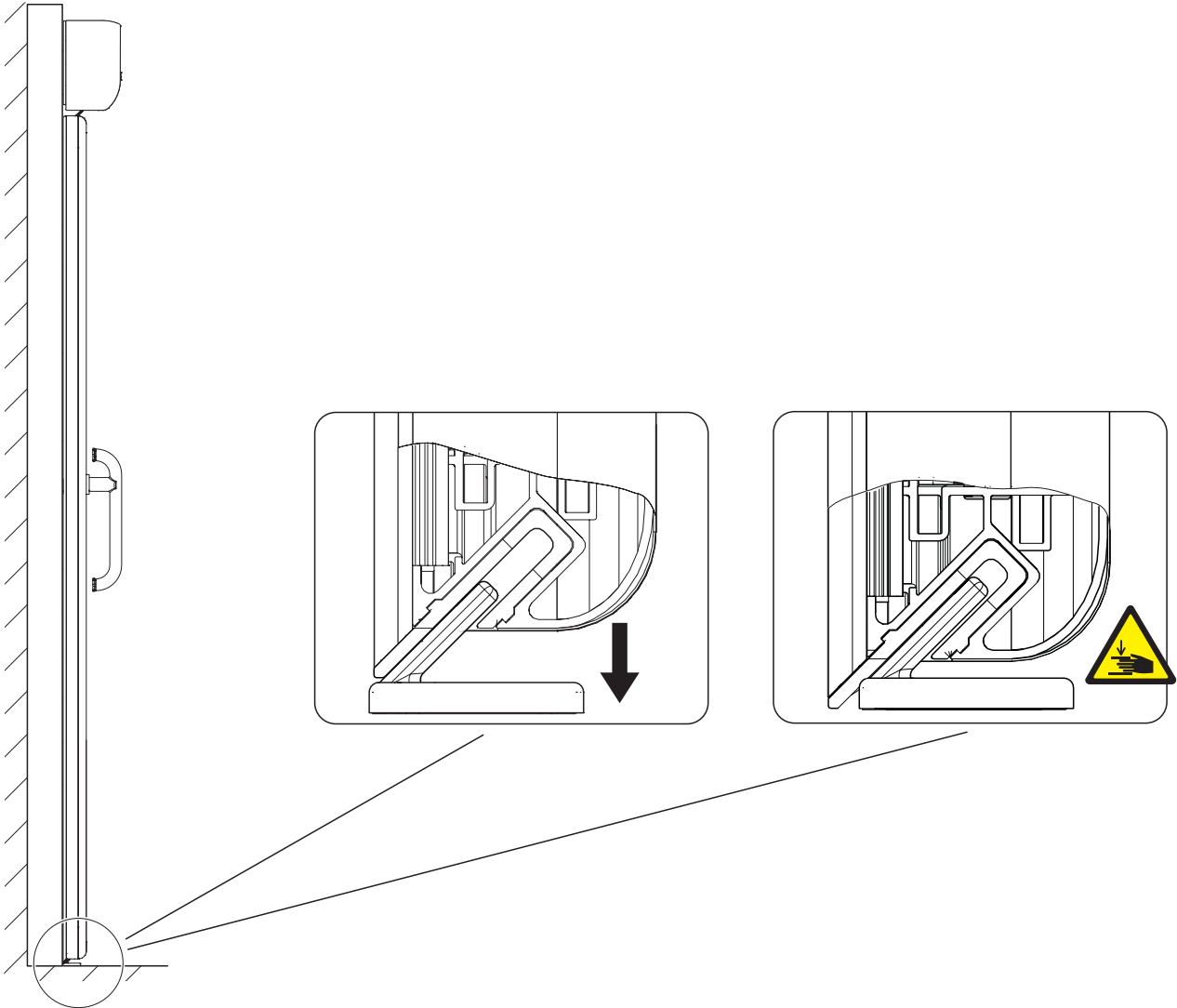

2.5 Set-up

i The door system shown is only a schematic diagram.
For technical reasons, we cannot show all of the possibilities here.
The operating elements can be arranged individually.

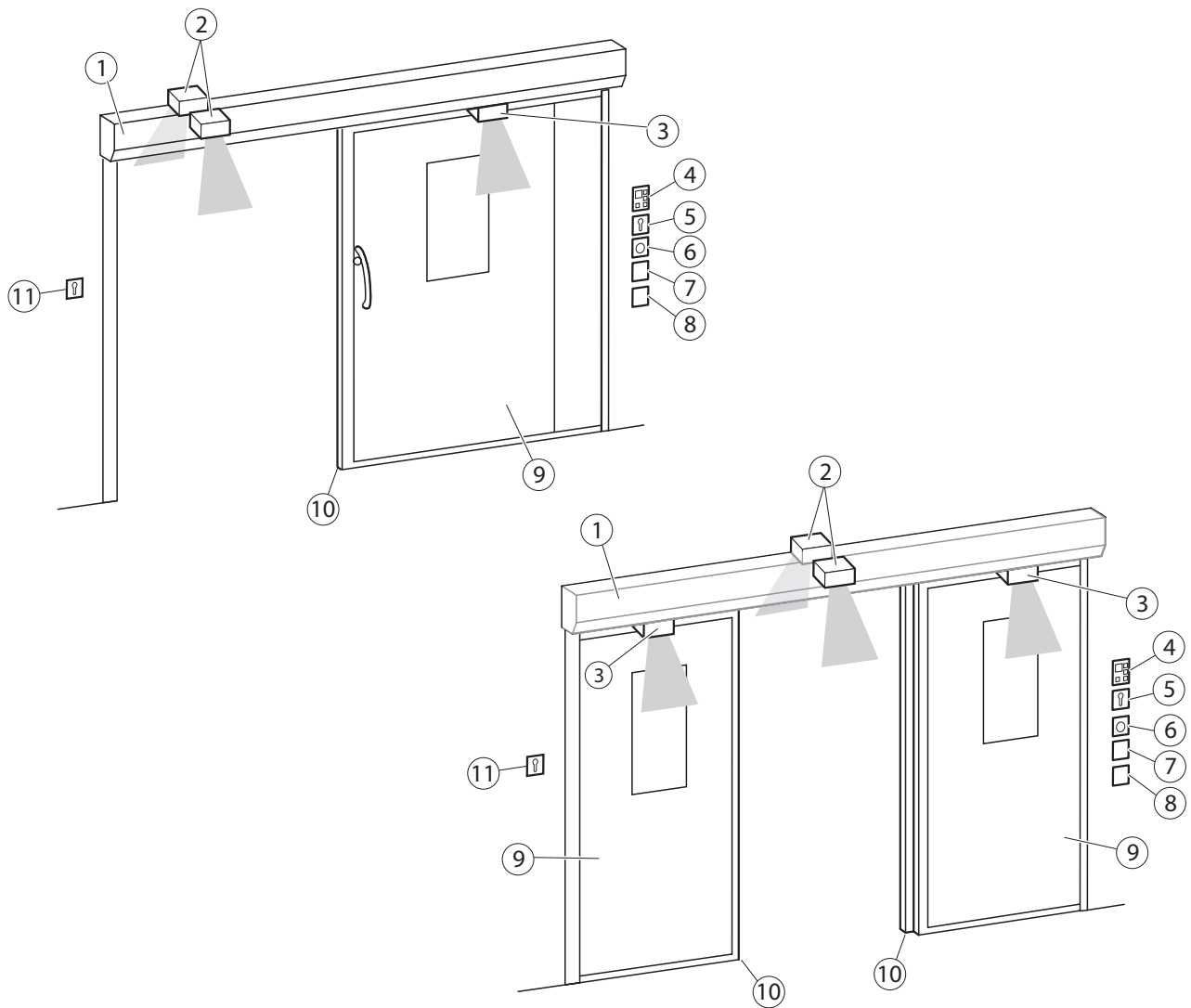

- | | | | |
|---|---|----|--|
| 1 | Drive | 7 | Nurse opening push button (reduced opening width) |
| 2 | Combined detectors | 8 | Bed opening push button (full opening width) |
| 3 | Safety sensor "open" | 9 | Door leaf |
| 4 | Programme switch | 10 | Floor guide |
| 5 | Key switch (optional) for enabling the programme switch | 11 | Authorised activation device (KB) for authorised opening (e.g. key switch) |
| 6 | Cleaning opening push button | | |

3 Operation

3.1 Normal operation

i GEZE sliding doors can be operated with special control elements, which can induce deviating behaviour. Ask the service technician responsible for information on any special control elements which may be installed.

3.1.1 Standard functions (automatic mode of operation)

In normal door operation, the door is automatically opened and closed.

What happens?	What does the door do?
An activation device (push button, switch or movement detector) is triggered.	Door opens and closes again.
Closing safety sensor is interrupted at an opened door.	Door remains open.
Closing safety sensor is interrupted at a closed door.	Door remains closed.
Closing safety sensor is interrupted while the door is closing.	Door opens again.
Opening safety sensor is interrupted at a closed door.	Door remains closed.
Opening safety sensor is interrupted while the door is opening.	Door stops.
A person moves toward the opened door and a movement detector is activated.	Door remains open.
A person moves toward the closing door and a movement detector is activated.	Door opens again.
Door contacts an obstruction when opening.	Door stops, waits and attempts to move to the open position at a reduced speed three times. Then the door closes again.
Door contacts an obstruction when closing.	Door reopens immediately, waits the hold-open time and then closes at a reduced speed.

3.1.2 Push & Go function

One of two Push & Go options can be selected.

Push & Go with hold-open time

What happens?	What does the door do?
Doors are pushed open.	Doors automatically continue the opening procedure to the learned reduced opening width. The door closes automatically after the set hold-open time.

Push & Go without hold-open time

What happens?	What does the door do?
Doors are pushed open.	Doors automatically continue the opening procedure to the learned reduced opening width and remain open.
Doors are pushed closed.	Doors continue the closing procedure automatically to the closed position.

i

- The functions via the contact sensor for automatic opening are active in Push & Go mode of operation.
- The safety functions with the Push & Go function are identical to the standard function.

3.1.3 Special functions

The special functions of the door system are triggered using special switches.

Switches/push buttons	What does the switch / push button do?
Authorised activation device bed opening	Door opens to the full opening width and closes again after the hold-open time has expired.
Push button nurse opening (activation device KI/KA)	Door opens to the reduced opening width and closes again after the hold-open time has expired.
Cleaning opening push button (input PE1)	Door opens to the full opening width and stays open. When actuated again, the door closes again.
Close push button opening (input PE2)	Door closes automatically. If a door is used with Push & Go without hold-open time after a manual passing and after the passing it has not closed, the doors can be closed centrally with this push button.
Key switch of the programme switch	If a key switch is connected to the programme switch, the operation of the programme switch can be locked or released with it
Emergency shut off switch (currentless)	Door opens and performs the function selected for battery operation: <ul style="list-style-type: none"> ▫ Open and switch off ▫ Close and switch off ▫ Normal operation for maximum 30 minutes or 30 open/close cycles, then open and switch off ▫ Normal operation for maximum 30 minutes or 30 open/close cycles, then close and switch off Door closes and remains closed
Emergency stop switch	Door stops and can be moved freely by hand

3.1.4 Function changes compared to DCU1 NT / DCU1-2-NT

The following functions are described in the user manual for Automatic Sliding Door Drives but are not yet available in the version DCU1-NT-OP:

- Limited hold-open setting
- Emergency lock

3.2 Selecting the mode of operation



The programme switches are accessible for everyone without a key switch.

As required, access to the programme switch can be restricted to authorised persons by an additional key switch or by assigning a password (ST220).

3.2.1 Display programme switch (DPS)

The operating modes can be set at the display programme switch by pressing the respective keys. Operation by unauthorised persons can be blocked as follows:

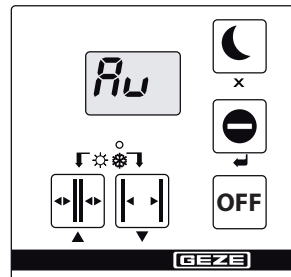

- Connection of an additional key switch
- or
- Assignment of a password which can be set in the Service menu of the ST220



Operating mode	Key	Display				Explanation
		DE	GB	FR	IT	
Automatic		<i>Au</i>	<i>Au</i>	<i>Au</i>	<i>Au</i>	Door opens and closes again. Inner and outer activation device active.
Shop closing (one-way operation)		<i>LS</i>	<i>Eo</i>	<i>Su</i>	<i>Su</i>	Inner activation device active. Outer activation device only active as long as door is not closed. Door only opens for passage from the inside to the outside.
Permanently open		<i>do</i>	<i>Hi</i>	<i>OP</i>	<i>PR</i>	Door remains open.
Night		<i>n0</i>	<i>no</i>	<i>ni</i>	<i>n-</i>	Displayed until door is closed and locked (if lock is present).
		<i>nR</i>	<i>ni</i>	<i>no</i>	<i>ni</i>	Door is closed and locked (if lock is present). Movement detector not active. Only authorised activation device is active.
Off (Service)		<i>OF</i>	<i>OF</i>	<i>OF</i>	<i>OF</i>	The drive is switched to without function for service purposes. The door leaves can be moved freely by hand. Activation and safety sensors are without function. Drive motor and locking are switched off.
Full opening width	+					Door opens the complete opening width. LED off
Reduced opening width *	+					Door opens only part of the possible opening width (can be set). LED lights up.

3.2.2 Keypad programme switch (TPS)

The system operating mode is selected and the corresponding programme is displayed at the keypad programme switch.









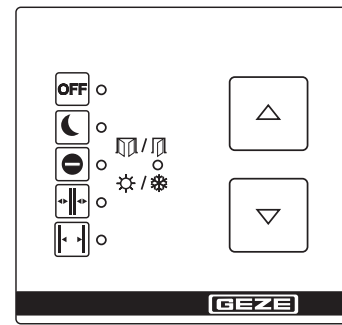































The desired operating mode of operation can be selected by activating the  and  keys. The LED of the current mode of operation lights up.

Operation by unauthorised persons can be blocked as follows:

- Connection of an additional key switch
- or
- Assignment of a password which can be set in the Service menu of the ST220

Keypad programme switch TPS



Operating mode	Key	Display	Explanation
Automatic	 or 	 ○  ○  ○  ●  ○	Door opens and closes again. Inner and outer activation device active.
▫ Full opening width	 + 	 /   / 	Door opens over the complete opening width.
▫ Reduced opening width	 + 	 /   / 	Door opens only part of the possible opening width (can be set).
Shop closing (one-way operation)	 or 	 ○  ○  ●  ○  ○	Inner activation device active. Outer activation device only active as long as door is not closed. Door only opens for passage from the inside to the outside.
Permanently open	 or 	 ○  ○  ○  ○  ●	Door remains open.
Night	 or 	 ○  ●  ○  ○  ○	Door is closed and locked (if lock is present). Movement detector not active. Only authorised activation device is active.

3.2.3 Mechanical programme switch (MPS, MPS-ST)

The desired mode of operation can be set by activating the rotary switch. The marking of the rotary switch must display the desired mode of operation.

The MPS-ST fulfils the same function as the MPS. The desired mode of operation can only be set using the supplied key. The programme switch is blocked when the key is removed.

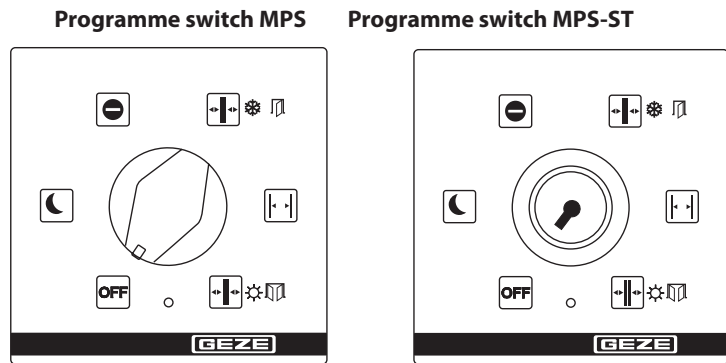

Operating mode	Setting	Explanation
Automatic		Door opens and closes again. Inner and outer activation device active.
▫ Full opening width		Door opens the complete opening width. Winter LED goes out.
▫ Reduced opening width		Door opens only part of the possible opening width (can be set).
Shop closing (one-way operation)		Inner activation device active. Outer activation device only active as long as door is not closed. Door only opens for passage from the inside to the outside.
Permanently open		Door remains open.
Night		Door is closed and locked (if lock is present). Movement detector not active. Only authorised activation device is active.
Off		Drive is deactivated, leaves can be moved by hand.

3.3 Blocking and releasing the operating mode

3.3.1 With DPS and TPS – blocking/releasing with additional key switch

- ▶ Turn key switch briefly to block function.
 - With the DPS, the function “operation blocked” is signalled by the display “- -” when any key is pressed.
 - With the TPS, the function “operation blocked” is signalled by the LED for the respectively set mode of operation flashing once when any key is pressed.
- ▶ Turn key switch again briefly for release.
Operation is then permanently released.

4 No mains voltage

 If the mains voltage fails (e.g. power failure), check the on-site safety fuse first.

State	Reaction
No mains voltage (e.g. power failure)	<p>The door remains closed and then locks in "Night" operating mode.</p> <p>Standard drives: In the operating modes shop closing, reduced opening width, full opening width and permanently open, the behaviour of the door depends on the parameters that have been set during the initial commissioning:</p> <ul style="list-style-type: none"> ▫ Door remains in the current position and switches off. ▫ With drives with built-in rechargeable battery depending on the function selected: <ul style="list-style-type: none"> ▫ Door closes and switches off. ▫ Door opens and switches off. ▫ Normal operation for maximum 30 minutes or 30 open/close cycles, then close and switch off. ▫ Normal operation for maximum 30 minutes or 30 open/close cycles, then open and switch off.
Mains voltage available again	<p>The door automatically returns to the last selected operating mode.</p>
Locking/unlocking without mains voltage active (e.g. power failure) for the toothed-belt lock	<p> Locking only makes sense when the door is closed.</p> <p>Locking with drives with built-in rechargeable battery</p> <ul style="list-style-type: none"> ▫ If the door is to be locked and this door is the only point of access: <ul style="list-style-type: none"> ▶ Push the door closed manually from the inside. ▶ Push the locking pin. ▶ Activate the inner authorised activation device until initialisation of the drive is completed. DPS or TPS indicates Night mode of operation. Door opens – leave the building – door closes – locks again and switches off. <p>Unlocking from the outside with drives with built-in rechargeable battery</p> <ul style="list-style-type: none"> ▶ Activate the outer authorised activation device until the drive is initialised and the door starts to open. Door opens – door closes – locks again and switches off. <p>Unlocking from the inside with drives with built-in rechargeable battery:</p> <ul style="list-style-type: none"> ▶ Activate the outer authorised activation device until the drive is initialised and the door starts to open. Door opens – door closes – locks again and switches off. <p>Unlocking with drives without built-in rechargeable battery (only possible from the inside)</p> <ul style="list-style-type: none"> ▶ Push the door to the desired locking position and push the locking pin (10, Chapter 2.5). <p>Unlocking with drives without built-in rechargeable battery (only possible from the inside)</p> <ul style="list-style-type: none"> ▶ Pull the locking pin (10, Chapter 2.5).

5 Fault messages

5.1 TPS/DPS

Display keypad programme switch					Designation	Display display programme switch
OFF	☾	⊖	⏪	⏩		
-	-	-	-	-	No operating voltage	
-	-	-	x	x	Drive too hot	45, 46, 48, 75, 78
-	-	x	-	x	Position	26, x.x
-	-	x	x	-	SIS	13, 19
-	-	x	x	x	Motor	10, 11, 12, 71, 72
-	x	-	-	x	Activation longer than 4 min	35, 36, 37, 38, 39, 40
-	x	-	x	x	Security interlocking door system, vestibule	33
-	x	x	-	-	Rechargeable battery	61
-	x	x	x	-	Opening time too long	64
x	-	-	-	x	Alarm	07, 08, 32, 42, 44
x	-	-	x	x	DCU104	50
x	-	x	-	-	SIO, BO	27, 29, 41
x	x	-	-	-	Mains power failure	03
x	x	-	-	-	Control unit	01, 02, 28, 47, 60, 63, 65, 70, 77, 79
x	x	x	-	-	Lock	16, 17, 18, 51

5.2 MPS/MPS-ST

If a fault occurs in the system, this is indicated by the LED lighting up permanently.







- ▶ Notify a service technician.

6 What to do if...?

Problem	Cause	Remedy
Door only opens and closes slowly	Floor guide area dirty	<ul style="list-style-type: none"> ▶ Disconnect power supply (emergency control or on-site safety fuse). ▶ Clean floor guide area.
	Obstruction in travel path	<ul style="list-style-type: none"> ▶ Remove obstruction and check door leaf for ease of movement.
	Closing safety sensor (SIS) interrupted or misaligned	<ul style="list-style-type: none"> ▶ Clean closing safety sensor (SIS) (light barrier). ▶ Check settings of light curtain.
Door opens and closes constantly	Obstruction in sliding path, e.g. stone in floor guide area	<ul style="list-style-type: none"> ▶ Disconnect power supply (emergency control or on-site safety fuse). ▶ Clear obstruction and clean floor guide area. ▶ Check detection field of movement detectors.
	Light beams or reflections, e.g. reflective floor, drops of rain, plants / flower pots, posters/displays or similar in the scanned area of the movement detector	<ul style="list-style-type: none"> ▶ Check detection field of movement detectors.
	Misaligned movement detector	<ul style="list-style-type: none"> ▶ Check detection field of movement detectors.
Door only opens a crack	Obstruction in travel path	<ul style="list-style-type: none"> ▶ Remove obstruction and check door leaf for ease of movement.
Door does not open	Obstruction in travel path	<ul style="list-style-type: none"> ▶ Remove obstruction and check door leaf for ease of movement.
	Movement detector misaligned or defective (inside and/or outside)	<ul style="list-style-type: none"> ▶ Check movement detector.
	Operating mode "Night", "OFF"	<ul style="list-style-type: none"> ▶ Select another operating mode.
	"Shop closing" operating mode	<ul style="list-style-type: none"> ▶ Select "Automatic" operating mode.

Problem	Cause	Remedy
	Floor locks are locked	▶ Unlock floor locks.
	Lock M is locked	▶ Unlock hook bolt lock.
	No mains voltage (e.g. power failure)	See Chapter 4, No mains voltage
Door does not unlock or lock	Locking defective	Unlock/lock the door manually: ▶ Check locking in the "Night" operating mode If the locking is defective: ▶ Notify a service technician.
Door does not close	Closing safety sensor (SIS) interrupted or misaligned	▶ Clean the closing safety sensor (SIS). ▶ Check settings of light curtain.
	Obstruction in travel path	▶ Remove obstruction and check door leaf for ease of movement.
	Movement detector triggers constantly	▶ Check movement detector.
	Operating mode "Permanently open", "OFF"	▶ Select another operating mode.
	No mains voltage (e.g. power failure)	See Chapter 4, No mains voltage
Programme switch cannot be operated	Programme switch is blocked Programme switch is defective	▶ Turn key switch. ▶ Enter password. ▶ Request servicing.
Fault messages displayed at programme switch	Fault in the door system	See Chapter 5, Fault messages

Carry out a reset/delete the fault memory

- TPS:
 - ▶ Use key  or  to change to the mode of operation OFF (see Chapter 3.2).
 - ▶ Press keys  and  simultaneously for 1 s.
- DPS with OFF key:
 - ▶ Activate keys  +  simultaneously for 1 s.

The function is not possible with DPS without OFF key.

The fault memory is deleted.

- ▶ Re-select mode of operation.

7 Cleaning and maintenance

7.1 Cleaning

What is to be cleaned	How is it to be cleaned
Safety sensor	Wipe with moist cloth.
Glass surfaces	Wipe with a cold vinegar/water mixture; then dry.
Stainless surfaces	Wipe with non-scratching cloth.
Coated surfaces	Wipe with water and soap.
Anodised surfaces	Wipe with non-alkaline potassium soap (pH value 5.5...7)
Programme switch	Wipe with damp cloth. Do not use a cleaning agent.

7.2 Maintenance

- 
 The owner must ensure that the system is working perfectly. In order to ensure faultless operation, the door system has to be maintained by a service technician when the maintenance indicator lights up.

The maintenance indicator is located on the programme switch. The version differs depending on the programme switch used:

Programme switch	Maintenance indicator
TPS	"Reduced opening width" LED flashes.
MPS, MPS-ST	LED flashes.
DPS	A red dot appears at the bottom right of the display.

The maintenance display lights up after the specified calendar period or number of opening cycles, depending on what occurs first:

- Calendar period: 1 year
- Opening cycles: 500,000

GEZE offers maintenance contracts with the following services:

- Cleaning and readjustment of carrier rollers and tracks
- Inspection and adjustment of toothed belts
- Inspection of door suspension plate and floor guide
- Inspection of fixing elements for firm fit
- Performance of miscellaneous adjustment work
- Performance of operational checks

7.3 Rechargeable battery

- 
 Information regarding the Battery Directive: (Applicable in Germany and all other countries in the European Union, together with the country's own regulations of a separate old battery-return system).

In accordance with the Battery Directive, we are obliged to inform you of the following in connection with the sale of batteries or rechargeable batteries respectively in connection with the delivery of devices containing batteries or rechargeable batteries:

Disposal of rechargeable batteries and batteries in household waste is not permitted. Disposal in household waste is expressly forbidden, according to the German Battery Act. As the end-consumer, you are legally obliged to return used batteries. Please dispose of batteries at a municipal collection point or in store. Batteries obtained from us can be returned to us by mail. The address is:

GEZE GmbH, Goods reception, Reinhold-Vöster-Str. 21-29, D-71229 Leonberg.



Batteries that contain hazardous substances are labelled with the symbol of a crossed-out garbage can. The chemical identifier of the harmful chemical, Cd for cadmium, Pb for lead, Hg for mercury, is located under the garbage can symbol.

Automatic sliding door systems from GEZE contain NiCd rechargeable batteries.

- NiCd rechargeable batteries must be replaced after 2 years at the latest.

8 Safety-related inspection by trained professionals

In compliance with

▫ DIN 18650-2 "Powered pedestrian doors – Part 2: Safety at powered pedestrian doors"; Section 5 and

▫ EN 16005 "Power operated pedestrian doorsets"; Chapter 4.2.1

the safe condition of power operated doors must be checked before initial commissioning, after material changes, and once a year by a professional authorised by GEZE.

GEZE offers the following services:

Inspection and functional checks of all safety and control equipment in compliance with the requirements in the test log for power-operated windows, doors and gates; Sliding doors and sliding gates BGG 950 (ZH 1/580.2) edition.

9 Technical data

9.1 General data

	Powerdrive PL-HT	ECdrive H
Opening speed	0.2 m/s ... 0.7 m/s	
Closing speed	0.2 m/s ... 0.5 m/s	
Electrical connection values	230 V; 50 Hz according to DIN IEC 38	
Connected load	max. 450 VA	max. 300 VA
Protection	Power connection 230 V, at customer 10 A	
Current consumption for external devices	24 V DC connection; max. 1000 mA	
Voltage in emergency battery operation	24 V; 700 mAh	
Temperature range	-15 °C to +50 °C; for dry rooms only	
IP rating	IP 20	

Subject to change

9.2 Dimensions

	Powerdrive PL-HT	ECdrive H
Opening width (mm)		
▫ 1-leaf	800-2500	700-2200
▫ 2-leaf	–	900-2200
Leaf weight (kg)		
▫ 1-leaf	200	120
▫ 2-leaf	–	2 × 120
Passage height, max. (mm)	The max. installation height for combined detectors is 3500 mm, for radar movement detectors 4000 mm	

Germany
GEZE GmbH
Niederlassung Süd-West
Tel. +49 (0) 7152 203 594
E-Mail: leonberg.de@geze.com

GEZE GmbH
Niederlassung Süd-Ost
Tel. +49 (0) 7152 203 6440
E-Mail: muenchen.de@geze.com

GEZE GmbH
Niederlassung Ost
Tel. +49 (0) 7152 203 6840
E-Mail: berlin.de@geze.com

GEZE GmbH
Niederlassung Mitte/Luxemburg
Tel. +49 (0) 7152 203 6888
E-Mail: frankfurt.de@geze.com

GEZE GmbH
Niederlassung West
Tel. +49 (0) 7152 203 6770
E-Mail: duesseldorf.de@geze.com

GEZE GmbH
Niederlassung Nord
Tel. +49 (0) 7152 203 6600
E-Mail: hamburg.de@geze.com

GEZE Service GmbH
Tel. +49 (0) 1802 923392
E-Mail: service-info.de@geze.com

Austria
GEZE Austria
E-Mail: austria.at@geze.com
www.geze.at

Baltic States
GEZE GmbH Baltic States office
E-Mail: office-latvia@geze.com
www.geze.com

Benelux
GEZE Benelux B.V.
E-Mail: benelux.nl@geze.com
www.geze.be
www.geze.nl

Bulgaria
GEZE Bulgaria - Trade
E-Mail: office-bulgaria@geze.com
www.geze.bg

China
GEZE Industries (Tianjin) Co., Ltd.
E-Mail: chinasales@geze.com.cn
www.geze.com.cn

GEZE Industries (Tianjin) Co., Ltd.
Branch Office Shanghai
E-Mail: chinasales@geze.com.cn
www.geze.com.cn

GEZE Industries (Tianjin) Co., Ltd.
Branch Office Guangzhou
E-Mail: chinasales@geze.com.cn
www.geze.com.cn

GEZE Industries (Tianjin) Co., Ltd.
Branch Office Beijing
E-Mail: chinasales@geze.com.cn
www.geze.com.cn

France
GEZE France S.A.R.L.
E-Mail: france.fr@geze.com
www.geze.fr

Hungary
GEZE Hungary Kft.
E-Mail: office-hungary@geze.com
www.geze.hu

Iberia
GEZE Iberia S.R.L.
E-Mail: info@geze.es
www.geze.es

India
GEZE India Private Ltd.
E-Mail: office-india@geze.com
www.geze.in

Italy
GEZE Italia S.r.l
E-Mail: italia.it@geze.com
www.geze.it

GEZE Engineering Roma S.r.l
E-Mail: roma@geze.biz
www.geze.it

Poland
GEZE Polska Sp.z o.o.
E-Mail: geze.pl@geze.com
www.geze.pl

Romania
GEZE Romania S.R.L.
E-Mail: office-romania@geze.com
www.geze.ro

Russia
OOO GEZE RUS
E-Mail: office-russia@geze.com
www.geze.ru

Scandinavia – Sweden
GEZE Scandinavia AB
E-Mail: sverige.se@geze.com
www.geze.se

Scandinavia – Norway
GEZE Scandinavia AB avd. Norge
E-Mail: norge.se@geze.com
www.geze.no

Scandinavia – Denmark
GEZE Danmark
E-Mail: danmark.se@geze.com
www.geze.dk

Singapore
GEZE (Asia Pacific) Pte, Ltd.
E-Mail: gezesea@geze.com.sg
www.geze.com

South Africa
GEZE Distributors (Pty) Ltd.
E-Mail: info@gezesa.co.za
www.geze.co.za

Switzerland
GEZE Schweiz AG
E-Mail: schweiz.ch@geze.com
www.geze.ch

Turkey
GEZE Kapı ve Pencere Sistemleri
E-Mail: office-turkey@geze.com
www.geze.com

Ukraine
LLC GEZE Ukraine
E-Mail: office-ukraine@geze.com
www.geze.ua

United Arab Emirates/GCC
GEZE Middle East
E-Mail: gezeme@geze.com
www.geze.ae

United Kingdom
GEZE UK Ltd.
E-Mail: info.uk@geze.com
www.geze.com

GEZE GmbH
Reinhold-Vöster-Straße 21–29
71229 Leonberg
Germany

Tel.: 0049 7152 203 0
Fax.: 0049 7152 203 310
www.geze.com

