



# TSA 325 NT Revolving doors

Original operating instructions

EN User manual

130509-03

## Contents

Supplied system .....	2
1 About these instructions .....	3
1.1 Symbols and illustrations.....	3
1.2 Product liability.....	3
2 Safety notices.....	3
3 Description .....	4
3.1 Intended use.....	4
3.2 Composition .....	4
3.3 GEZE door variants .....	5
3.4 GEZE building designs .....	5
4 Operation .....	6
4.1 Normal door operation.....	6
4.2 Additional door functions .....	6
4.3 Selecting the operating mode.....	6
4.4 Locking/unlocking (optional).....	9
4.5 Behaviour in an emergency .....	9
5 No mains voltage.....	10
6 Fault messages on the TPS-KDT .....	10
7 What to do if...? .....	11
8 Cleaning and maintenance.....	12
8.1 Maintenance.....	12
8.2 Cleaning .....	12
8.3 Inspection by an expert.....	13
9 Disposal.....	13
10 Technical data.....	13

## Supplied system

3-leaf variant	<input type="checkbox"/>	3
4-leaf variant	<input type="checkbox"/>	4
Manual revolving door	<input type="checkbox"/>	M
With automatic positioning device	<input type="checkbox"/>	P
Automatic revolving door	<input type="checkbox"/>	A
Servo revolving door	<input type="checkbox"/>	S
All-glass	<input type="checkbox"/>	GG
Break-out function	<input type="checkbox"/>	BO
Burglar-resistant	<input type="checkbox"/>	RC2
Underfloor drive	<input type="checkbox"/>	UFA
Manual night-time closer	<input type="checkbox"/>	NV
Automatic night-time closer	<input type="checkbox"/>	ANV
Internal manual night-time closer	<input type="checkbox"/>	INV
Internal automatic night-time closer	<input type="checkbox"/>	IANV



Example: TSA 325 NT BO = Revolving door TSA 325 NT with break-out function

# 1 About these instructions

## 1.1 Symbols and illustrations

### Symbols and illustrations

Important information and technical notes are highlighted to explain correct operation.

Symbol	Meaning
	means "important note"
	means "additional information"
	<p>Symbol for an action: There is something you must do here.</p> <ul style="list-style-type: none"> <li>▶ If there are several actions to be taken, keep to the given order.</li> </ul>

## 1.2 Product liability

In compliance with the liability of the manufacturer for their products as defined in the German "Product Liability Act", the information contained in this brochure (product information and intended use, misuse, product performance, product maintenance, obligations to provide information and instructions) must be observed. Non-observance releases the manufacturer from their liability.

# 2 Safety notices

Carefully read and abide by this user manual before commissioning the door. Always observe the following safety instructions:

- ▶ Make sure that the relevant accident prevention regulations and standards EN 16005 and DIN 18650 are kept.
- ▶ Observe any relevant additional national and European directives.
- ▶ Operating, maintenance and repair conditions specified by GEZE must be observed.
  - Maintenance and repair work may only be performed by properly trained personnel authorised by GEZE.
  - Only trained, GEZE-authorised personnel may open the cover.
  - GEZE shall assume no liability for damage caused by unauthorised changes to the system.
  - The door system is solely suitable for use in entrances and interior areas of pedestrian traffic in commercial plants and public areas.
  - The owner is responsible for safe operation of the system. If safety equipment is misaligned, causing it to no longer fulfil its intended purpose, further operation is no longer permissible. Inform the service technician immediately.
  - In compliance with Machinery Directive 2006/42/EC, EN 16005 and DIN 18650, a safety analysis must be performed and the door system identified in accordance with CE Marking Directive 93/68/EEC before the door system is commissioned.
  - If there are any glass breakages (ceiling, leaf or drum wall), put the door out of use immediately and use suitable measures to prevent anyone entering the area (e.g. barrier tape). Notify a service technician.

### 3 Description

#### 3.1 Intended use

The door system is solely suitable for use in entrances and interior areas of pedestrian traffic in commercial plants and public areas. Make sure the door system is used for this purpose during operation.

Heed the following points when using the door system:

- ▶ Make sure that the electrically powered turnstile is not accelerated manually.
- ▶ Adapt the walking speed of the door system.
- ▶ Make sure that the opening is large enough for entering and leaving the door system.
- ▶ Do not stand still in the door system or change directions.
- ▶ Ensure sufficient distance to the drum wall and the revolving leaf.
- ▶ Do not stand still in the direct vicinity of the door entrance or exit.
- ▶ Do not enter the door carrying bulky objects or pushing a trolley (e.g. shopping trolley).
- ▶ Make sure children are always accompanied when they enter the door system.
- ▶ Keep children at play away from the door system.
- ▶ Keep animals on a short lead or carry them.

The door system must be used for the intended purpose so that the revolving door safety sensors do not unexpectedly slow or stop the door system in operation.

**i** In certain conditions, changing weather conditions (wind, snow, rain, bright sunshine) can cause brief interruptions or standstill of the door system. This is not a fault, rather it is to guarantee user safety.

#### 3.2 Composition

**i** The operating elements are arranged differently depending on the situation. For technical reasons, we cannot show all of the possibilities here. The door system shown is only a schematic diagram.

##### System parts and options

- 1 Movement detector inside
- 2 Movement detector outside
- 3 Front post safety sensor
- 4 Emergency-stop button inside and outside
- 5 Keypad programme switch
- 6 Key push button
- 7 Warning notice inside and outside
- 8 Disabled person's button
- 9 Post safety
- 10 Heel protection strip
- 11 Vertical safety contact strip
- 12 Mobile safety sensor

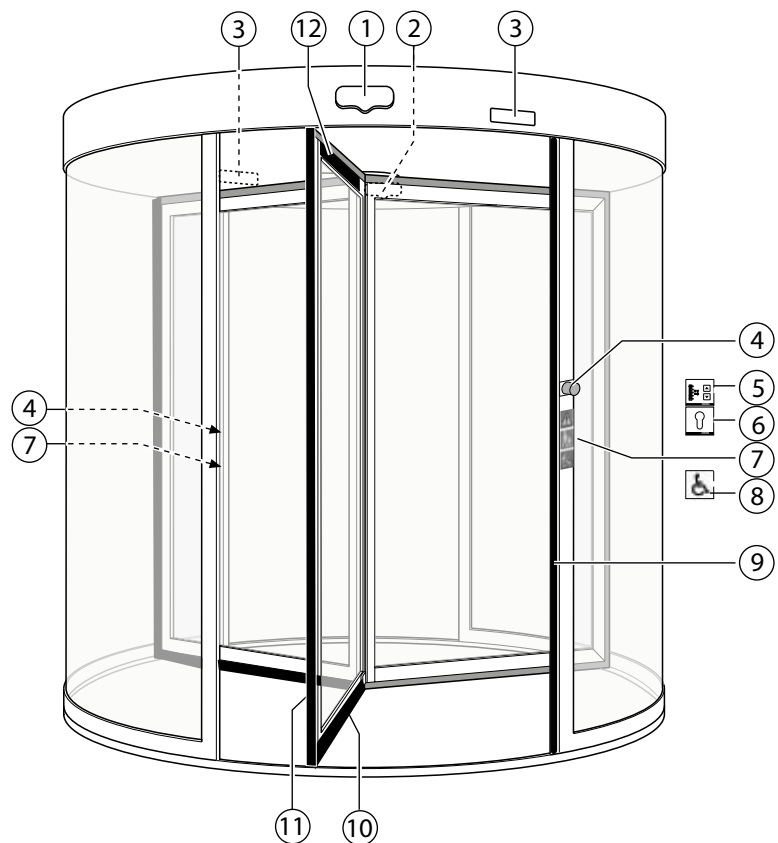

### 3.3 GEZE door variants

Door variant	Special feature
Manual doors	Doors without safety function, exclusively for manual use
Manual doors with speed limiter	The max. speed of the revolving door is limited by a safety mechanism in the door.
Manual doors with automatic positioning device	Once it has been passed, the manual door is moved motor-driven to its initial/end position at very low speed. The programme switch must be set to the manual mode of operation.
Servo doors	Increased comfort compared with a manual door thanks to automatic starting of the turnstile with radar movement detector. In order to reach walking speed, the turnstile can be overridden by hand. After the door has been passed, it revolves slowly to the final position. The speeds are limited. The programme switch must be set to the manual mode of operation.
Fully automatic revolving doors	Activation via movement detector. Electromechanical drive with two pre-adjustable speeds. The revolving movement starts automatically.

### 3.4 GEZE building designs

Building design	Special feature
GG variant (all-glass)	The drum walls do not have a frame at the top or bottom and the door has a glass roof.
GD variant (glass roof)	The drum walls have a frame and the door has a glass roof.
BO variant (break out)	The revolving leaves can be broken out in any position by pressing the outer edge of the leaf. When a leaf is broken out, the drive is switched off immediately. The door leaves can be engaged again by hand. Then the door continues revolving until it reaches its end position.
RC2 variant	Burglar-resistant fitting system tested in accordance with DIN EN 1627 - 1630. Special version of the night-time closer, drum walls and roof.

## 4 Operation

### 4.1 Normal door operation

**i** GEZE revolving doors can be operated with special control elements, which deviate from the behaviour described here. Please ask the service technician responsible for information on the special control elements which are installed.

During normal door operation the door revolves as long as persons are within the range of influence of the sensors.

What happens?	What does the door do?
A contact sensor (push button, switch or movement detector) is triggered.	The door begins to revolve.
The safety sensor (start safety) triggers because an object has been detected between the leaves.	The door slows down to a standstill if necessary.
Safety sensor (front post safety) is triggered when the door revolves.	As soon as the passing leaf comes nearer than the pre-set danger distance, the door slows down to a standstill.
Safety sensor on the side element (post safety sensor) is triggered.	The door slows down to a standstill.
Safety sensors on the leaf (draw-in safety) touch an obstruction and are triggered.	The door slows down to a standstill.



### 4.2 Additional door functions

In addition to the keypad programme switch, various additional functions control the door manually via switches or push buttons.

Which switch/push button?	What does the switch/push button do?
Emergency stop push button	The door brakes to a standstill and can be revolved freely.
Key push button of the keypad programme switch	If a key push button is connected to the keypad programme switch, the operation of the keypad programme switch can be locked or released with it.
Contact sensor "Authorised" (e.g. outside key push button)	The door unlocks and revolves in accordance with the number of sectors set and lets the person pass.
Activation detector	The door revolves at full speed
Disabled person's button	The door slows and revolves at reduced speed

### 4.3 Selecting the operating mode

The system operating mode is selected and the corresponding programme is displayed at the keypad programme switch.

The operating mode is changed by pushing the  or  buttons.

The current operating mode is indicated by permanent illumination of the corresponding LED.





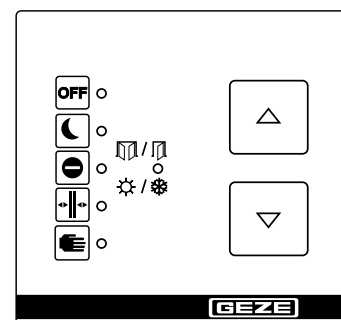

The TPS-KDT indicates the actual operating mode, even if the operating mode is changed via another operating mode input (e.g. additionally fitted switches or GLT system).

**Keypad programme switch TPS-KDT**

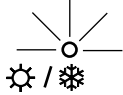

The keypad programme switch is accessible for everyone. Therefore we recommend the use of an additional key push button in order to block the keypad programme switch. The keypad programme switch is only enabled while the key push button is operated.

Changing the operating mode of the TPS can also be protected by setting parameters for a password to prevent the operating mode being changed by unauthorised persons. The password can only be set and changed by a service technician. The password for operating the keypad programme switch (TPS-KDT) has 2 digits (01 ... 99). The arrow keys are used for entry. The factory setting is 00 (released).

Operating mode	TPS-KDT	Explanatory notes
Automatic		<p>All the connected pulse generators are active in the "Automatic" operating mode. Revolving speed and time delay can be set. When triggered by a movement detector the door accelerates to the set automatic speed, continues to revolve at this speed and stops in the target position after a preset number of sectors.</p> <p>The following special functions are possible in the "Automatic" operating mode:</p> <p><b>Summer operation</b> The turnstile stands still without activation. When activated for the first time, the revolving door accelerates to automatic speed. After that the revolving door revolves at the automatic speed for a number of sectors that can be set and then slows to the run-on speed. The revolving door revolves at the slow speed for a set time delay and then stops in the next target position. This operating mode is particularly suitable for creating a welcoming atmosphere. If the time delay is set to endless, the revolving door revolves permanently.</p> <p><b>Winter operation</b> The turnstile stands still without activation. When activated, the revolving door accelerates to the automatic speed. After that the revolving door revolves at the automatic speed for a number of sectors that can be set and then stops in the target position.</p> <p>In "Automatic" operating mode, alteration between summer and winter operation can be affected by simultaneously pressing the buttons  and .</p> <p>If winter operation is selected, the LED "Winter" is illuminated in the TPS-KDT.</p> <div style="text-align: center;"></div> <p><b>Activation of disabled person's button (optional)</b> A switch with a wheelchair symbol is located on the door. When this switch is activated, the door brakes and revolves at the set disabled access speed. This speed is specified for the set number of sectors.</p>
Shop closing		In the "Shop closing" operating mode the door is only actuated via the internal movement detector, then revolves for a set number of sectors at automatic speed and then stops again in the target position.
Manual		<p>The turnstile can be rotated freely in manual operation. If no further functions are set, the "Manual" operating mode is identical with the "Off" operating mode. The following options can be set:</p> <ul style="list-style-type: none"> <li>▫ An automatic positioning device returns the door to the target position at slow speed after passing has been completed.</li> <li>▫ Safety devices can be activated.</li> <li>▫ The speed limiter can be activated.</li> <li>▫ Prescribed mode of operation for revolving doors with automatic positioning device and servo revolving doors.</li> </ul>
Night		<p>The following options for locking can be built into the system in order to lock it in the "Night" operating mode:</p> <p><b>No locking</b> If the revolving door does not have a locking function, it can be revolved manually in the "Night" operating mode.</p>

Operating mode	TPS-KDT	Explanatory notes
----------------	---------	-------------------

Night



**Manual locking**

A rod locking can be used as a manual locking element. A contact used to monitor the locking operating mode is installed.

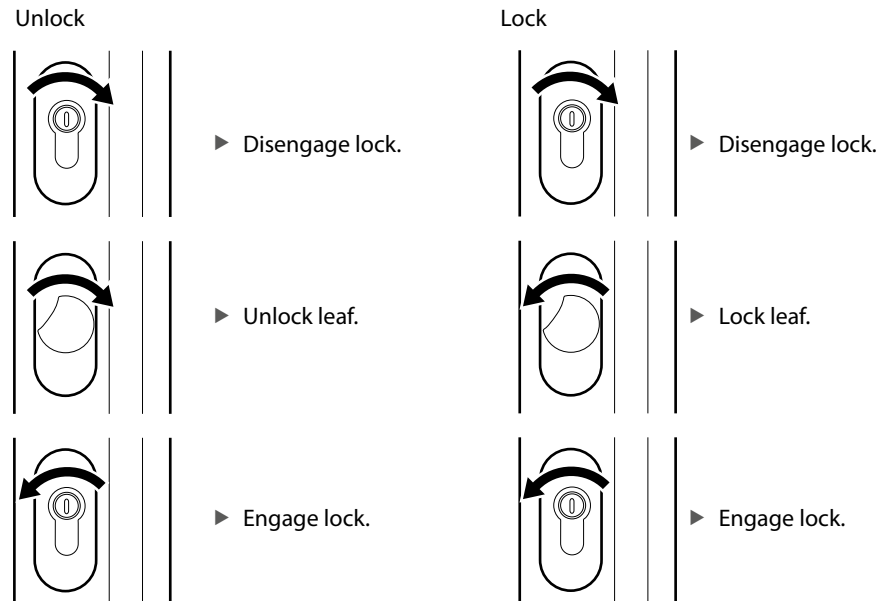

**i** In the break-out (BO) and all-glass (GG) variants the leaf locking mechanism can also function reversed.

To lock the door manually:

- ▶ Select the "Night" operating mode at the keypad programme switch. The Night LED flashes on the TPS-KDT.
- The door revolves automatically to the locking position.
- ▶ Lock the locking device manually.
- The Night LED switches to being permanently illuminated.

Unlocking the door manually:

- ▶ Unlock the locking device manually.
- The Night LED of the TPS-KDT switches to flashing.
- ▶ Set the desired operating mode on the TPS-KDT.
- The LED indicates the operating mode.

**Locking device with disc brake**

A disc brake can be used to lock the revolving door. When the power supply is interrupted, the brake is opened. The revolving door can then be revolved manually. It is not suitable for a revolving door with break-out function.

Locking the door:

- ▶ Select the "Night" operating mode on the TPS-KDT.
- The Night LED flashes on the TPS-KDT.
- The door revolves automatically to the locking position.
- The disc brake is activated.
- The Night LED switches to being permanently illuminated.

Unlocking the door:



- ▶ Select the desired operating mode on the TPS-KDT.
- The disc brake is released.
- The new operating mode is active and is displayed on the TPS-KDT.

**Electromechanical lock**

One or two electromechanical locks can be used to lock the revolving door. A locked door remains locked when the power fails. An unlocked door remains unlocked when the power fails. In the case of a power failure the lock can be unlocked by means of a built-in battery.

- ▶ Select the "Night" operating mode at the keypad programme switch.
- The door moves to the end position and locks automatically.



Operating mode	TPS-KDT	Explanatory notes
Night		<p><b>Option: Revolving door suitable for use in escape and rescue routes.</b></p> <p>Only with the break out variant (BO) with a separate key push button for locking.</p> <ul style="list-style-type: none"> <li>▶ During the slow movement into the end position, press the key operated button and keep it pressed.</li> </ul> <p>The door locks automatically in the end position.</p> <ul style="list-style-type: none"> <li>▶ Release the key operated button again.</li> <li>▶ In order to unlock the door, activate the key operated button and switch on the desired operating mode at the button programme switch.</li> </ul> <p>Access via the contact sensor authorised (only at revolving doors suitable for use in escape and rescue routes):</p> <ul style="list-style-type: none"> <li>▶ Operate the authorised contact sensor (I think).</li> </ul> <p>The door revolves once.</p> <ul style="list-style-type: none"> <li>▶ In order to lock the door hold the authorised contact sensor authorised until the door has locked automatically.</li> </ul> <p><b>Locking in the event of a power failure</b></p> <hr/> <p> In order to avoid the danger of persons being locked in, the revolving door may not be entered when the locking bolts are lowered and may only be turned further from the outside. A special locking switch is required for locking and unlocking.</p> <hr/> <p><b>Locking with night-time closer</b></p> <p>The revolving door can be locked with a 1-leaf or 2-leaf night-time closer (manual or automatic).</p> <p>Manual night-time closer: The procedure is identical to manual locking.</p> <p>Automatic night-time closer:</p> <ul style="list-style-type: none"> <li>▶ Select the "Night" operating mode on the TPS-KDT.</li> </ul> <p>The door revolves automatically to the locking position.</p> <ul style="list-style-type: none"> <li>▶ In order to lock the night-time closer, activate the key push button and hold it until the night-time closer is closed and locked.</li> <li>▶ In order to open the night-time closer, activate the switch and hold it until the night locking system is open.</li> <li>▶ Select the desired operating mode on the TPS-KDT.</li> </ul>
Off		<ul style="list-style-type: none"> <li>▶ In the "Off" operating mode the motor is switched off and the door can be freely revolved manually. This operating mode is especially suitable for maintenance and cleaning of the door. All actuation devices are switched off.</li> </ul>

#### 4.4 Locking/unlocking (optional)

For a description of locking/unlocking the door, see Section 4.3 "Selecting the operating mode", Night operating mode.



If a revolving door suitable for escape and rescue routes is used, the operator must ensure that the door really is unlocked after it has been unlocked.

#### 4.5 Behaviour in an emergency

The door can be stopped via the emergency stop switch and moved manually.

Revolving doors with break out system (BO) can be opened in any position by pressing the outer edge of the leaf (< 220 N), clearing a suitable escape route. The drive is switched off immediately after the leaf has been broken out and the turnstile can be revolved manually.

## 5 No mains voltage



► If the mains voltage fails (e.g. power failure), check the on-site safety fuse first.

State	Reaction
No mains voltage	In "Night" operating mode, the door remains locked as long as a disc brake was not used. In other operating modes the door coasts to standstill and stops.
Mains voltage available again	The door starts again in the previously set operating mode.
Door leaves revolve if there is no active power supply	The door can be revolved manually providing it was not locked.

## 6 Fault messages on the TPS-KDT

If a fault occurs in the system, a fault code is displayed every 5 seconds (several LEDs), alternating with the operating mode (one LED). Up to 20 different fault messages can be displayed.

► Read the fault message, record it and notify the service technician.

TPS display	Description
○ ○ ○ ○ ○	No operating voltage
○ ○ ○ ● ●	Drive too hot
○ ○ ● ○ ●	Position
○ ○ ● ● ○	Post safety
○ ○ ● ● ●	Motor, rotary transducer, initialisation sensor
○ ● ○ ● ○	Emergency stop
○ ● ○ ● ●	Draw-in safety (post safety sensor/vertical safety contact strip)
○ ● ● ○ ○	Rechargeable battery
○ ● ● ○ ●	Frequency converter
○ ● ● ● ○	Start safety (accompanying safety)
● ○ ○ ○ ●	Alarm
● ○ ○ ● ○	Front post safety
● ○ ○ ● ●	Disc brake
● ○ ● ○ ○	Break out
● ○ ● ○ ●	24 V internal (fuse F1)
● ○ ● ● ○	24 V external
● ● ○ ○ ●	Power failure
● ● ○ ● ○	Control, motor relay
● ● ○ ● ●	Keypad programme switch
● ● ○ ○ ○	Service terminal
● ● ● ○ ○	Locking

In addition, the following states are displayed:

- Non-taught Winter LED flashes continuously (1 s on, 3 s off)
- Maintenance Winter LED flashes continuously (0.5 s on, 0.5 s off)
- Fault Operating mode displayed for 5 sec., fault code for 2 sec.
- Block active Current operating mode LED flashes once if a key is pressed on the TPS and if the operating mode cannot be switched (key push button not operated or there is a permanent signal at the input DO, AU, LS or NA).

## 7 What to do if...?

Problem	Cause	Remedy
Door revolves very slowly	Floor area soiled	<ul style="list-style-type: none"> <li>▶ Interrupt power supply.</li> <li>▶ Clean the affected floor area.</li> </ul>
	Obstruction in travel path	▶ Remove obstruction and check door manually for smooth movement.
	Start safety sensor is interrupted or misaligned	<ul style="list-style-type: none"> <li>▶ Clean safety sensor.</li> <li>▶ Check the setting of the optical safety sensors.</li> </ul>
	Scraping on floor, other mechanical impediment	▶ Revolve the door manually, remove visible obstacles. If no obstacles are visible, notify a service technician.
Door does not revolve	Movement detector misaligned or defective	<ul style="list-style-type: none"> <li>▶ Check movement detector.</li> <li>▶ Notify a service technician.</li> </ul>
	"Night", "Off" operating mode	▶ Select another operating mode.
	"Shop closing" operating mode	▶ Select "Automatic" operating mode.
	Door is locked manually	▶ Unlock the door.
	No mains voltage	▶ See Section 5, "No mains voltage".
	Emergency stop push button pressed	▶ Unlock emergency stop push button.
	Door leaf has been broken out (BO variant)	▶ Engage the door leaf again by hand and wait for the door system to start up.
	Door only revolves manually	"Off" operating mode
No mains voltage		▶ See Section 5, "No mains voltage".
Door always revolves only a bit further	Obstruction in travel path	<ul style="list-style-type: none"> <li>▶ Remove the obstruction.</li> <li>▶ Notify a service technician.</li> <li>▶ Change to the "Manual" operating mode and check the movement force manually. If the revolving force is too high, notify a service technician.</li> </ul>
Door does not unlock or lock (in case of automatic locking)	Locking defective	<ul style="list-style-type: none"> <li>▶ Check locking in the "Night" operating mode.</li> <li>▶ Unlock the door manually and notify a service technician.</li> </ul>
	Key push button not activated	▶ Actuate the key push button, repeat the unlocking process.
Programme switch cannot be operated	Programme switch is blocked	▶ Activate key push button.
	Programme switch is defective	▶ Request service.
Fault messages displayed at programme switch	Fault in the door system	▶ See Section 6, "Fault messages on the TPS-KDT".
Glass break (door leaf/drum wall)	Impact on pane	▶ Put the door out of operation immediately and take suitable measures to prevent anyone entering the door (e.g. barrier tape).
		▶ Notify a service technician.

**Carry out a reset/delete the fault memory**

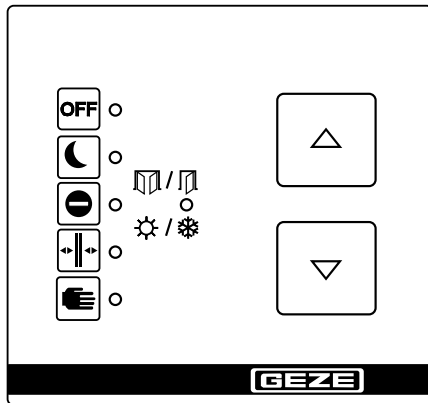

- ▶ Use key or to change to the mode of operation OFF (see Section 4.3 "Selecting the operating mode").
- ▶ Press keys and simultaneously for 1 s. The fault memory with the current faults is deleted.
- ▶ Select the desired new mode of operation.

## 8 Cleaning and maintenance

### 8.1 Maintenance

The owner must ensure that the system functions perfectly.

Daily:

- ▶ Use suitable equipment to check the safety devices (e.g. emergency stop switch).
- ▶ Subject the door system to a visual inspection for loose parts, sharp edges and broken glass.
- ▶ Check that there is sufficient lighting in the passage area.
- ▶ Check the floor condition (obstructions, danger of slipping, unevenness).

Weekly:

- ▶ Clean the door system, see Section 8.2, "Cleaning".

If the "Winter" LED on the TPS-KDT keypad programme switch flashes continuously, maintenance is required.

GEZE offers maintenance contracts with the following services:

- Inspect and adjust the chain.
- Check the leaf suspension.
- Check the attachment elements for firm seating.
- Performance of miscellaneous adjustment work.
- Performance of operational checks.

### 8.2 Cleaning

What is to be cleaned	How is it to be cleaned
Floor guide, night-time closer	<ul style="list-style-type: none"> <li>▶ Remove the soiling and check that the door moves smoothly.</li> <li>▶ Keep free of snow and ice in winter.</li> </ul>
Safety sensor	<ul style="list-style-type: none"> <li>▶ Wipe with moist cloth.</li> </ul>
Glass surfaces	<ul style="list-style-type: none"> <li>▶ Wipe with a cold vinegar-water mixture or glass cleaner; then dry.</li> </ul>
Stainless surfaces	<ul style="list-style-type: none"> <li>▶ Wipe with non-scratching cloth.</li> </ul>
Coated surfaces	<ul style="list-style-type: none"> <li>▶ Wipe with water and soap.</li> </ul>
Anodised surfaces	<ul style="list-style-type: none"> <li>▶ Wipe with non-alkaline potassium soap (pH value 5.5...7)</li> </ul>
Keypad programme switch	<ul style="list-style-type: none"> <li>▶ Wipe with damp cloth. Do not use a cleaning agent.</li> </ul>
Brushes on the revolving leaves	<ul style="list-style-type: none"> <li>▶ Clean weekly with the vacuum cleaner.</li> </ul>
Floor mat	<ul style="list-style-type: none"> <li>▶ Clean/vacuum clean at regular intervals.</li> <li>▶ Lift up the floor mat and vacuum clean under it.</li> </ul>

### 8.3 Inspection by an expert

In compliance with standards DIN 18650 and EN 16005, the safe state of power operated doors must be checked before initial operation and at least once a year by an expert.

GEZE offers the following services:

Inspection and functional checks on all safety and control equipment in compliance with the requirements in the test log for power operated windows, doors and gates; sliding doors and sliding gates ZH 1/580.2 edition.

## 9 Disposal

The door system is made up of materials that should be sent for recycling.

- ▶ Sort the individual components in accordance with the type of material.

The parts can be disposed of by a recycling company.

Batteries and rechargeable batteries contain pollutants and heavy metals.

- ▶ Do not dispose of batteries and rechargeable batteries with household waste.
- ▶ Observe national legal regulations.



Information regarding the Battery Directive:

(Applicable in Germany and in all other member states of the European Union as well as in other European countries, together with the countries' own provisions for a separate waste battery collection system.)



In accordance with the Battery Directive, we are obliged to inform you of the following in connection with the sale of batteries or rechargeable batteries respectively in connection with the delivery of devices containing batteries or rechargeable batteries: Rechargeable batteries and batteries must not be disposed of with household waste. Disposal with household waste is expressly forbidden according to the Battery Directive. As the final consumer, you are bound by law to return waste batteries and rechargeable batteries. Please return waste batteries and rechargeable batteries to a communal collection point or retailer.

Following use, you may return any batteries or rechargeable batteries received from us by post. The address is: GEZE GmbH, Incoming Goods, Reinhold-Vöster-Str. 21-29, 71229 Leonberg/Germany.

Batteries which contain harmful substances are identified by a symbol of a crossed-out rubbish bin.

The chemical designation of the harmful substance is specified underneath the rubbish-bin symbol:

Cd for Cadmium, Pb for lead, Hg for mercury.

## 10 Technical data

Revolving speed	$\varnothing \leq 3.0 \text{ m}$ : 0.2 up to max. 1 m/sec $\varnothing > 3.0 \text{ m}$ : 0.2 to max. 0.75 m/sec
Electrical connection values	230 V, 50-60 Hz pursuant to DIN IEC 38
Max. output	350 W
Current consumption for external devices	Mains connection 230 V, on-site fuse protection 10 A 24 V DC connection; fuse protection max. 4.0 A
Temperature range	-15 °C to +50 °C
IP rating	Ceiling drive: IP 20 Underfloor operator: IP 54



Subject to change.





**Germany**  
GEZE GmbH  
Niederlassung Süd-West  
Tel. +49 (0) 7152 203 594  
E-Mail: leonberg.de@geze.com

GEZE GmbH  
Niederlassung Süd-Ost  
Tel. +49 (0) 7152 203 6440  
E-Mail: muenchen.de@geze.com

GEZE GmbH  
Niederlassung Ost  
Tel. +49 (0) 7152 203 6840  
E-Mail: berlin.de@geze.com

GEZE GmbH  
Niederlassung Mitte/Luxemburg  
Tel. +49 (0) 7152 203 6888  
E-Mail: frankfurt.de@geze.com

GEZE GmbH  
Niederlassung West  
Tel. +49 (0) 7152 203 6770  
E-Mail: duesseldorf.de@geze.com

GEZE GmbH  
Niederlassung Nord  
Tel. +49 (0) 7152 203 6600  
E-Mail: hamburg.de@geze.com

GEZE Service GmbH  
Tel. +49 (0) 1802 923392  
E-Mail: service-info.de@geze.com

**Austria**  
GEZE Austria  
E-Mail: austria.at@geze.com  
www.geze.at

**Baltic States**  
GEZE GmbH Baltic States office  
E-Mail: office-latvia@geze.com  
www.geze.com

**Benelux**  
GEZE Benelux B.V.  
E-Mail: benelux.nl@geze.com  
www.geze.be  
www.geze.nl

**Bulgaria**  
GEZE Bulgaria - Trade  
E-Mail: office-bulgaria@geze.com  
www.geze.bg

**China**  
GEZE Industries (Tianjin) Co., Ltd.  
E-Mail: chinasales@geze.com.cn  
www.geze.com.cn

GEZE Industries (Tianjin) Co., Ltd.  
Branch Office Shanghai  
E-Mail: chinasales@geze.com.cn  
www.geze.com.cn

GEZE Industries (Tianjin) Co., Ltd.  
Branch Office Guangzhou  
E-Mail: chinasales@geze.com.cn  
www.geze.com.cn

GEZE Industries (Tianjin) Co., Ltd.  
Branch Office Beijing  
E-Mail: chinasales@geze.com.cn  
www.geze.com.cn

**France**  
GEZE France S.A.R.L.  
E-Mail: france.fr@geze.com  
www.geze.fr

**Hungary**  
GEZE Hungary Kft.  
E-Mail: office-hungary@geze.com  
www.geze.hu

**Iberia**  
GEZE Iberia S.R.L.  
E-Mail: info@geze.es  
www.geze.es

**India**  
GEZE India Private Ltd.  
E-Mail: office-india@geze.com  
www.geze.in

**Italy**  
GEZE Italia S.r.l.  
E-Mail: italia.it@geze.com  
www.geze.it

GEZE Engineering Roma S.r.l.  
E-Mail: roma@geze.biz  
www.geze.it

**Poland**  
GEZE Polska Sp.z o.o.  
E-Mail: geze.pl@geze.com  
www.geze.pl

**Romania**  
GEZE Romania S.R.L.  
E-Mail: office-romania@geze.com  
www.geze.ro

**Russia**  
OOO GEZE RUS  
E-Mail: office-russia@geze.com  
www.geze.ru

**Scandinavia – Sweden**  
GEZE Scandinavia AB  
E-Mail: sverige.se@geze.com  
www.geze.se

**Scandinavia – Norway**  
GEZE Scandinavia AB avd. Norge  
E-Mail: norge.se@geze.com  
www.geze.no

**Scandinavia – Denmark**  
GEZE Danmark  
E-Mail: danmark.se@geze.com  
www.geze.dk

**Singapore**  
GEZE (Asia Pacific) Pte, Ltd.  
E-Mail: gezesea@geze.com.sg  
www.geze.com

**South Africa**  
GEZE Distributors (Pty) Ltd.  
E-Mail: info@gezesa.co.za  
www.geze.co.za

**Switzerland**  
GEZE Schweiz AG  
E-Mail: schweiz.ch@geze.com  
www.geze.ch

**Turkey**  
GEZE Kapı ve Pencere Sistemleri  
E-Mail: office-turkey@geze.com  
www.geze.com

**Ukraine**  
LLC GEZE Ukraine  
E-Mail: office-ukraine@geze.com  
www.geze.ua

**United Arab Emirates/GCC**  
GEZE Middle East  
E-Mail: gezeme@geze.com  
www.geze.ae

**United Kingdom**  
GEZE UK Ltd.  
E-Mail: info.uk@geze.com  
www.geze.com

**GEZE GmbH**  
Reinhold-Vöster-Straße 21–29  
71229 Leonberg  
Germany

Tel.: 0049 7152 203 0  
Fax.: 0049 7152 203 310  
www.geze.com

